

**HYUNDAI**  
POWER PRODUCTS

# ELECTRIC BRUSHCUTTER & GRASSTRIMMER

## HDCBE1400

**ORIGINAL INSTRUCTIONS**

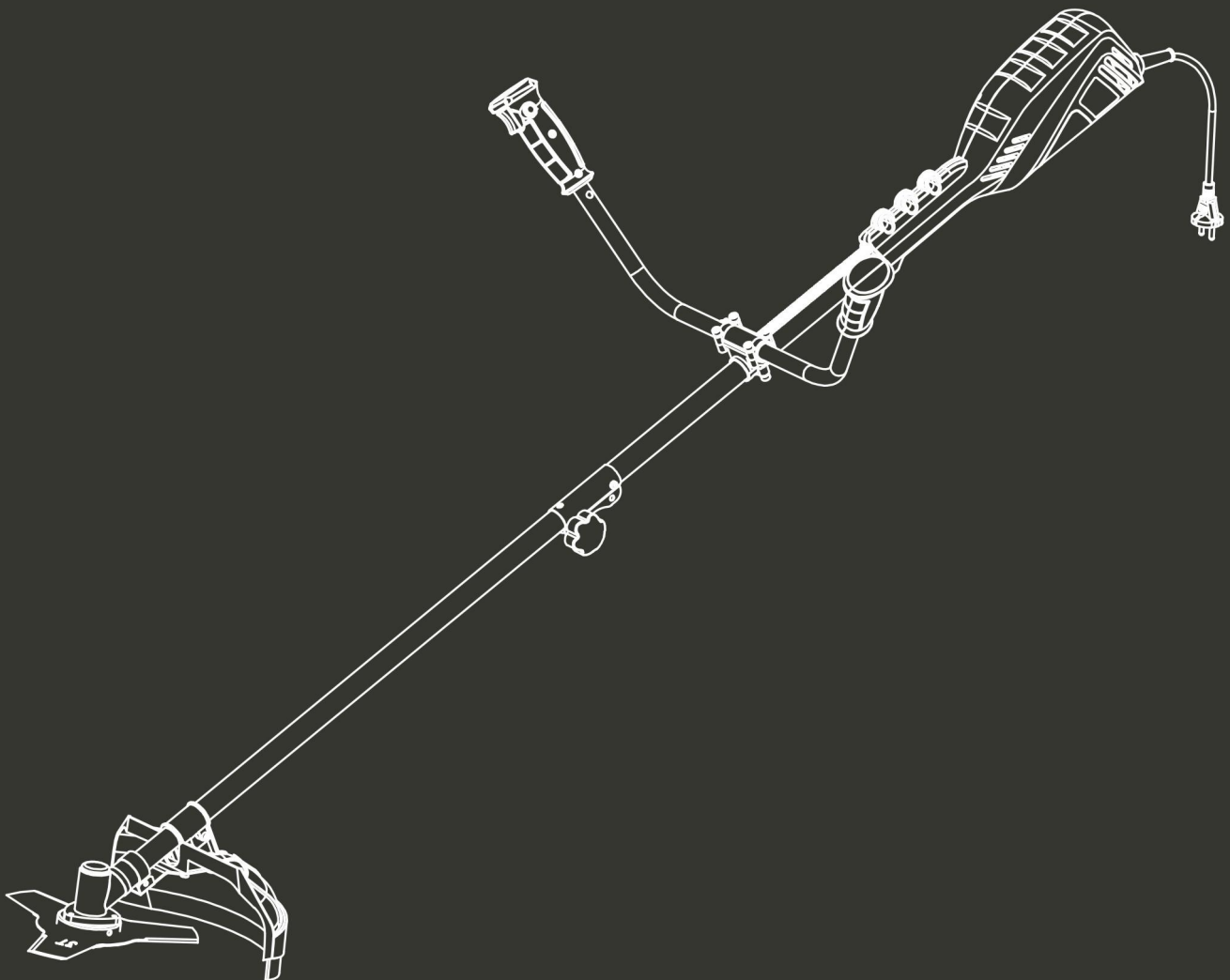

**WARNING:** Read thoroughly the instruction manual before using.

# CONTENTS

1. SAFETY INSTRUCTIONS.....	3
2. YOUR PRODUCT.....	15
3. ASSEMBLY.....	16
4. OPERATION.....	22
5. MAINTENANCE AND STORAGE.....	27
6. DISPOSAL.....	32
7. DECLARATION OF CONFORMITY.....	34
8. WARRANTY.....	35
9. PRODUCT FAILURE.....	36
10. WARRANTY EXCLUSIONS.....	37

# 1. SAFETY INSTRUCTIONS

## Safe operating practices

### Training

- a) Read the instructions carefully. Be familiar with the controls and the correct use of the machine.
- b) Never allow children or people unfamiliar with these instructions to use the machine. Local regulations can restrict the age of the operator.
- c) Keep in mind that the operator or user is responsible for accidents or hazards occurring to other people or their property.

### Preparation

- a) Before use check the supply and extension cord for signs of damage or aging. If the cord becomes damaged during use, disconnect the cord from the supply immediately. **DO NOT TOUCH THE CORD BEFORE DISCONNECTING THE SUPPLY.** Do not use the machine if the cord is damaged or worn.
- b) Before use, always visually inspect the machine for damaged, missing or misplaced guards or shields.
- c) Never operate the machine while people, especially children, or pets are nearby.

### Operation

- a) Keep supply and extension cords away from cutting means.
- b) Wear eye protection and stout shoes at all times while operating the machine.
- c) Avoid using the machine in bad weather conditions

especially when there is a risk of lightning.

d) Use the machine only in daylight or good artificial light.

e) Never operate the machine with damaged guards or shields or without guards or shields in place.

f) Switch on the motor only when the hands and feet are away from the cutting means.

g) Always disconnect the machine from the power supply (remove the plug from the mains):

1. whenever the machine is left unattended;

2. before clearing a blockage;

3. before checking, cleaning or working on the machine;

4. after striking a foreign object;

5. whenever the machine starts vibrating abnormally.

h) Take care against injury to feet and hands from the cutting means.

i) Always ensure that the ventilation openings are kept clear of debris.

## **Maintenance and storage**

a) Disconnect the machine from the power supply (i.e. remove the plug from the mains, remove the disabling device or removable battery) before carrying out maintenance or cleaning work.

b) Use only the manufacturer's recommended replacement parts and accessories.

c) Inspect and maintain the machine regularly. Have the machine repaired only by an authorized repairer.

d) When not in use, store the machine out of the reach of children.

## **Recommendation**

The machine should be supplied via a residual current device (RCD) with a tripping current of not more than 30 mA.

## **Additional instructions**

Proper safety precautions must be observed. Like all power equipment this unit must be handled carefully. **DO NOT EXPOSE YOURSELF OR OTHERS TO DANGER.** Follow these general rules. Do not permit others to use this machine unless they are thoroughly responsible and have read, and understand the machine manual and are trained in its operation.

- This appliance is not intended for use by persons (including children) with reduced physical, sensory or mental capabilities, or lack of experience and knowledge, unless they have been given supervision or instruction concerning use of the appliance by a person responsible for their safety.
- Children should be supervised to ensure that they do not play with the appliance.
- This product must be and operated by experienced users only. It is important that non experienced users get a full training before using this tool
- If you give this machine to another person, please also provide it with this instruction manual.
- Always wear safety goggles for eye protection. Dress properly; do not wear loose clothing or jewelry that could become caught in moving parts of the unit. Safe, sturdy, nonskid footwear should always be worn. Long hair

should be tied back. It is recommended that legs and feet be covered to protect from flying debris during operation.

- Inspect the entire machine for loose parts (nuts, bolts, screws, etc.) and any damage. Repair or replace as necessary before using the machine. DO NOT USE any attachment with this power head other than the ones recommended by our company. Serious injury to the operator or bystanders could result as well as damage to the machine.

- Always use proper handles and shoulder strap when cutting.

- Never attempt to make engine adjustments while the unit is running and strapped to the operator. Always make engine adjustments with the unit resting on a flat, clear surface.

- Do not use the unit if it is damaged or poorly adjusted. Never remove the machine's guard. Serious injury to the operator or bystanders could result as well as damage to the machine.

- Inspect the area to be cut and remove all debris that could become entangled in the nylon cutting head. Also remove any objects that the unit may throw during cutting.

- Keep children away. Onlookers should be kept at a safe distance from the work area, at least 15 meters (50 FEET).

- Never leave the machine unattended.

- Do not use this unit for any job other than those for which it is intended as described in this manual.

- Do not overreach. Keep proper footing and balance at all times. Do not run the unit while standing on a ladder or on any other unstable footing location.
- Keep hands and feet clear of the nylon cutting head or blade while unit is in use.
- Do not use this type of machine for sweeping away debris.
- Do not use the unit when you are tired, ill or under the influence of medication, drugs or alcohol.
- Use nylon cutting head which is free of damage. If a stone or any other obstacle is hit, stop the engine and check the nylon cutting head. A broken or unbalanced nylon cutting head must never be used.
- Store in a locked, well-ventilated area only.
- Ensure safe and proper performance of your product. These parts are available from your dealer. The use of any other accessories or attachments may cause a potential hazard or injury to the user, damage to the machine and void this warranty.
- Clean the machine completely, especially, the fuel tank, its surroundings, and the air cleaner.
- Stay clear of other workers or bystanders by at least 15 meters/50 feet.
- Whenever approaching an operator of the machine, carefully call his attention and confirm that the operator stop the engine. Be careful not to startle or distract the operator which can cause an unsafe situation.
- Never touch the nylon cutting head or blade whenever the engine is running. If it is necessary to replace the

protector or cutting attachment, be sure to stop the engine and confirm that the cutting device has stopped running.

- The engine should be turned off when the machine is moved between work areas
- Be careful not to hit the nylon cutting head against stones, or the ground.
- Unreasonable rough operation will shorten the life of the machine as well as create an unsafe environment for yourself and those around you.
- Pay attention to loosening and overheating of parts. If there is any abnormality of the machine, stop operation immediately and check the machine carefully. If necessary, have the machine serviced by an authorized dealer. Never continue to operate a machine which may be malfunctioning.
- Pay special attention to operation in the rain or just after the rain as the ground may be slippery.
- If you slip or fall to the ground or into a hole, release the throttle lever immediately.
- Be careful not to drop the machine or hit it against obstacles.
- Before proceeding to adjust or repair the machine, be sure to stop the engine and detach the spark plug.
- Make periodic inspections to assure safe and efficient operation. For a thorough inspection of your machine, please contact a dealer.
- It is believed that a condition called Raynaud's phenomenon, which affects the fingers of certain



individuals, may be brought about by exposure to vibration and cold. Loss of color and numbness in the fingers. The following precautions are strongly recommended because the minimum exposure which might trigger the ailment is unknown.

- Keep your body warm, especially the head, neck, feet, ankles, hands and wrists.
- Maintain good blood circulation by performing vigorous arm exercises during frequent work breaks and also by not smoking.
- Limit the hours of operation. Try to fill each day with jobs where operating the brush cutter or other hand-held power equipment is not required.
- If you experience discomfort, redness and swelling of the fingers followed by whitening and loss of feeling, consult your physician before further exposing yourself to cold and vibration.
- Always wear ear protection, loud noise for long time can make hearing debase even lost hearing.
- Wear a total face and head protection.
- Wear no-slip heavy duty work gloves to improve your grip on the brush cutter handle. Gloves also reduce the transmission of machine vibration to your hands.
- **WARNING:** The cutter area is still dangerous while the machine is coasting to a stop.
- When transport, this unit must be handled carefully. Do not expose yourself or others to danger.
- Envelop the blade before storage. Keep children away from it.

- Never remove the machine's guard.
- Do not store in a closed area where fuel vapors can reach an open flame from hot water heaters, furnaces, etc. Store in a locked, well-ventilated area only.
- Never place the machine in any places where there are flammable materials (dry grass, etc.), combustible gasses or combustible liquids.
- National regulation can restrict the use of the machine.
- Never modify a trimmer or cutter in any way.
- Improper use of the machine can cause **SERIOUS OR FATAL PERSONAL INJURY**.
- The extension cable shall not be lighter than the standardized code H05 RN-F/H05 VV-F. See your retailer or manufacturer for more advice.
- Supply cord must be replaced by manufacturer, service agent or qualified persons when it is damaged.
- Never to replace the non-metallic cutting means with metallic cutting means.
- Walk on slopes, never run
- **WARNING:** Never to touch moving hazardous parts before the machine is disconnected from the mains and the moving hazardous parts have come to a complete stop
- **WARNING:** Never to connect a damaged cord to the supply or touch a damaged cord before it is disconnected from the supply.
- When the power extension cord is damaged or ageing, should be replaced by manufacturer, service agent or

qualified persons.

- If the electrical cable is damaged, please immediately switch off the power supply.
- If the supply cord is damaged, it must be replaced by the manufacturer, its service agent or similarly qualified persons in order to avoid a hazard.

## **Kickback and Related Warnings**

- Kickback is a sudden reaction to a pinched or snagged rotating wheel, backing pad, brush or any other accessory. Pinching or snagging causes rapid stalling of the rotating accessory which in turn causes the uncontrolled power tool to be forced in the direction opposite of the accessory's rotation at the point of the binding.
- For example, if an abrasive wheel is snagged or pinched by the workpiece, the edge of the wheel that is entering into the pinch point can dig into the surface of the material causing the wheel to climb out or kick out. The wheel may either jump toward or away from the operator, depending on direction of the wheel's movement at the point of pinching. Abrasive wheels may also break under these conditions.
- Kickback is the result of power tool misuse and/or incorrect operating procedures or conditions and can be avoided by taking proper precautions as given below.

**a) Never place your hand near the rotating accessory.** Accessory may kickback over your hand.

**b) Do not position your body in the area where power tool will move if kickback occurs.** Kickback will propel the tool in direction opposite to the wheel's movement at

the point of snagging.

**c) Use special care when working corners, sharp edges etc. Avoid bouncing and snagging the accessory.** Corners, sharp edges or bouncing have a tendency to snag the rotating accessory and cause loss of control or kickback.



### **Residual risks**











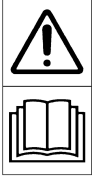

Even if you use this power tool correctly, there are always residual risks. The following hazards may arise in connection with the structure and manufacture of this power tool:

1. Hearing impairment if no suitable hearing protection is worn.
2. Cuts if no suitable protective clothing is worn.
3. Health damage resulting from vibration in the hands and arms if the device is used for a long period of time or is not handled and maintained properly.

Warning! This machine generates an electromagnetic field during operation. This field may, in certain circumstances, affect active or passive medical implants. To reduce the risk of serious injury or death, persons with medical implants should consult their physician and the medical implant manufacturer before using the machine.

#### **Explanation of symbols**

	This graphic accompanied by the words WARNING and DANGER calls attention to an act of a condition which can lead to SERIOUS INJURY.
	ALWAYS WEAR EYE PROTECTION, EAR PROTECTION AND HEAD PROTECTION.

	<p>READ &amp; UNDERSTAND Operator's Manual and Safety Manual.</p>
	<p>Wear a Head protection.</p>
	<p>GUARANTEE SOUND POWER LEVEL.</p>
	<p>Distance between bystanders and the tool must be at least 15m.</p>
	<p>People must kept away from the work area.</p>
	<p>Do not expose to rain and humidity.</p>
	<p>Be careful to the rebound.</p>
	<p>Caution: If the electrical cable is damaged, please immediately switch off the power supply.</p>
	<p>Do not use metal blades! (Unless otherwise stated in this manual).</p>
	<p>Watch out for projections! Keep viewers away from work area.</p>
	<p>Wear protective gloves.</p>
	<p>Wear protective shoes.</p>

**Intended use**

This machine can be used with the cutting wire as a trimmer for cutting grass and weeds of small thickness and in small quantity and with the cutting blade as a brush cutter for cutting denser vegetation. This machine must not be used for cutting or other cutting operations where the cutting tool must be lifted above the ground. This machine is only authorized for private use. Any other use or modification of this machine is prohibited and involves high risks.

## 2. YOUR PRODUCT

### a. Description

1

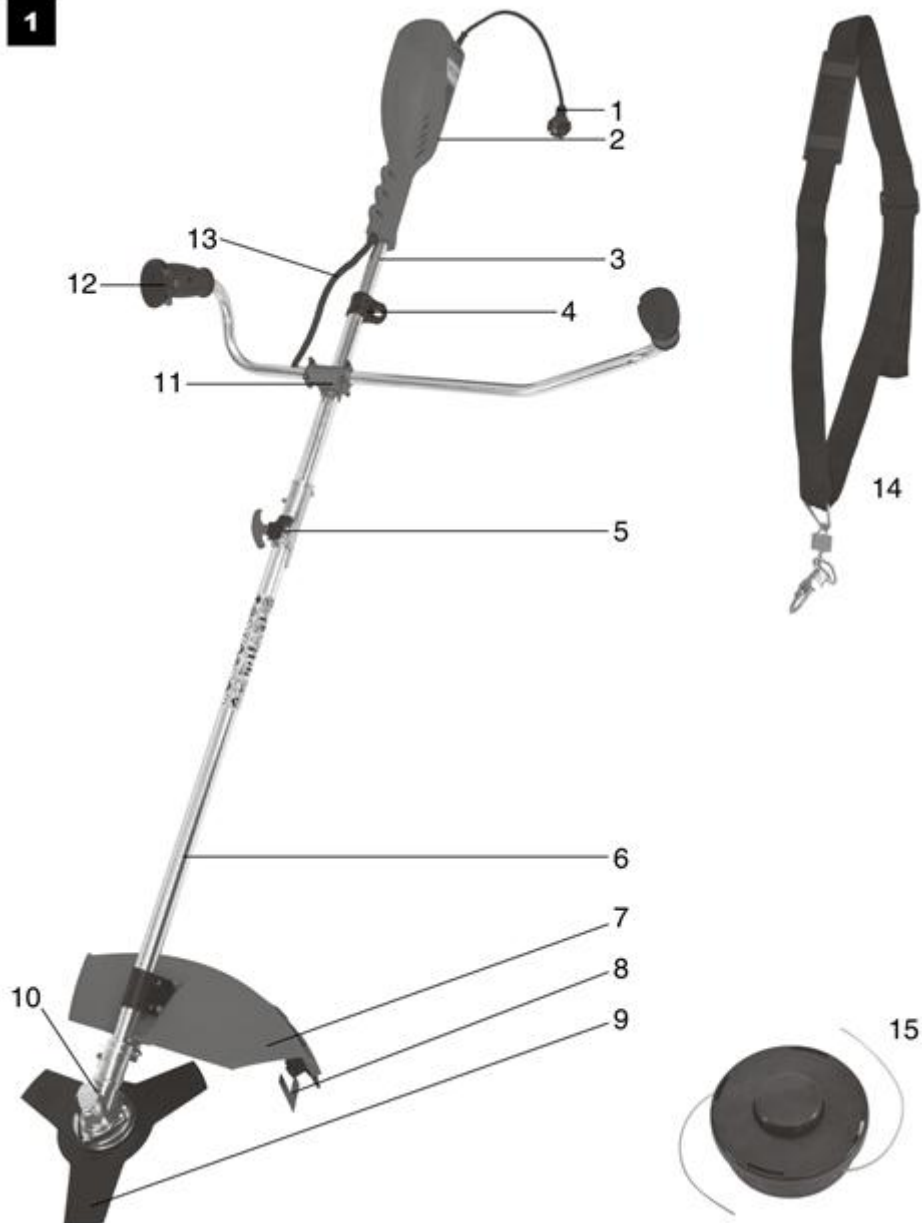

- |                         |   |
|-------------------------|---|
| 1. Supply cable         | 9. Metal cutting blade  |
| 2. Motor                | 10. Angle drive   |
| 3. Upper tube shaft     | 11. Handlebar support   |
| 4. Harness support      | 12. Handle and handle with switch on/off and switch-lock release button |
| 5. Connector            | 13. Electrical wiring   |
| 6. Lower tube shaft     | 14. Harness   |
| 7. Carter of protection | 15. Cutting head  |
| 8. Wire cutting line    |   |

### b. Technical data

Model	<b>HDCBE1400</b>
Power	1400 W
Voltage	230V~50Hz
Speed (brushcutter)	8500 /min

Cutting diameter (brushcutter)	255mm
Thickness cutting (brushcutter)	1.4mm
Speed (grass trimmer)	7200 /min
Cutting diameter (grass trimmer)	420mm
Cutting thickness (grass trimmer)	Φ1.6mm
Weight)	5.2 kg
Sound pressure level	LpA : 75 dB(A) ; K= 3.0dB(A)
Sound power level	LwA : 95 dB(A) ; K= 3.0dB(A)
Guarantee sound power level	L <sub>WA</sub> : 96 dB(A)
Vibrations	4.421 m/s <sup>2</sup> K= 1.5 m/s <sup>2</sup>

### 3. ASSEMBLY

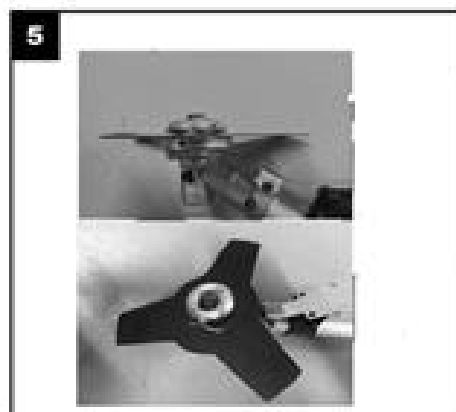
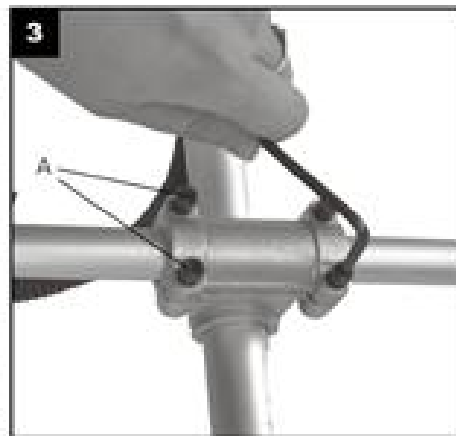
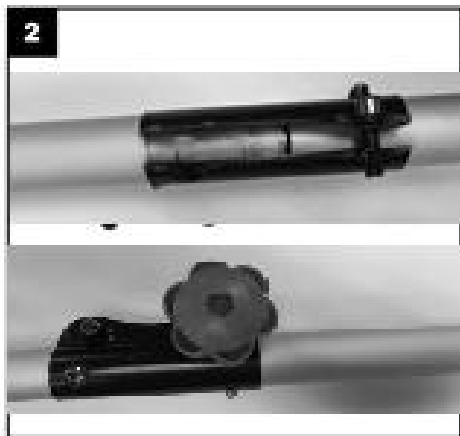

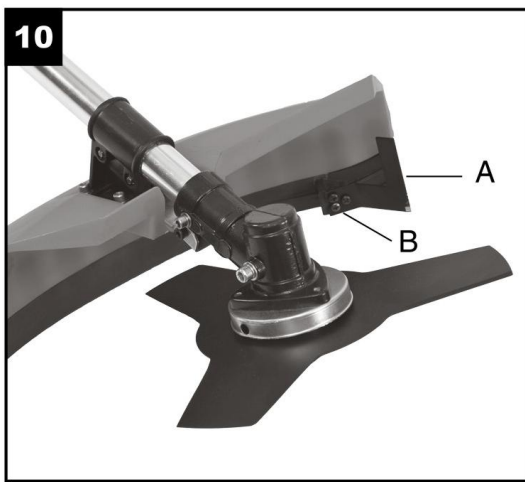
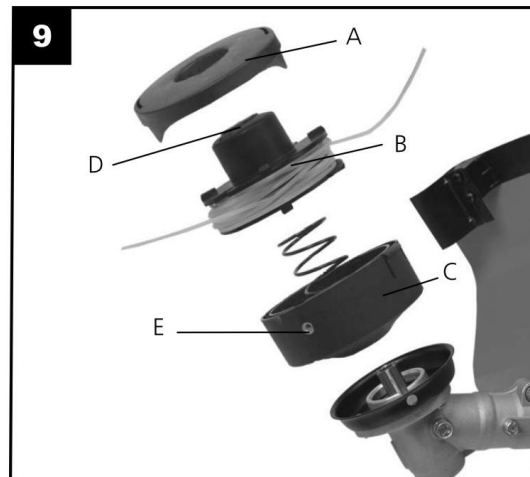
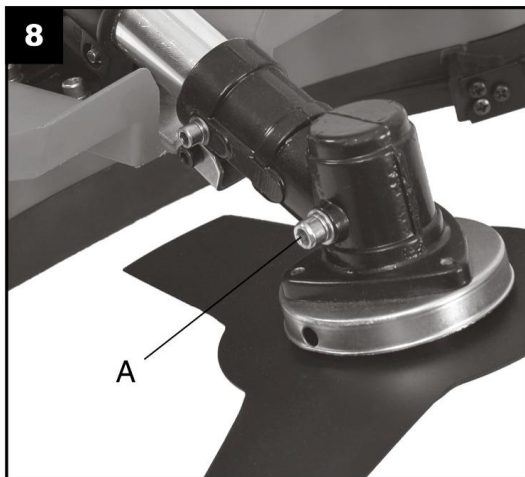

**Before working on the device, disconnect it from the power supply.  
Use only original parts and be careful when assembling the brushcutter. Risk of injury!  
Before working, you must mount the safety guard on the cutting device, and the two tubes.  
Assemble the tool as explained below and use the pictures above.**

### **MOUNTING THE TWO TUBES OF THE SHAFT (FIG 2)**

1. Push the two parts of the tubular shaft together (hole at the top of the bottom tube); you will hear a click.
2. Put and tighten the screw cap in the correct direction.
3. Before starting the machine, check that the lower tube is firmly installed and secured. Before starting the machine, make sure that the rod of the tube is closed and secure and that it is in the correct position.

### **Dismantling**

to disassemble, proceed in the reverse direction of 8.1, Lift the cover plate, press the locking tab and remove the lower tube.

### **MOUNTING THE HANDLEBAR (FIG 3)**

1. Loosen the 4 Allen screws (A) on the upper tube and remove the handlebar bracket.
2. Insert the handlebar onto the bracket; tighten it with the bracket and the 4 Allen screws (as shown).
3. Secure the cable with cable ties (rilsan type)  
Make sure the wiring is not bent or broken.

### **MOUNTING THE CARTER OF PROTECTION (FIG 4)**

Place the protective cover on the shaft. Screw the Allen screws as shown.



### **MOUNTING THE METAL CUTTING BLADE (FIG 5)**

when working with the metal cutting blade, wear gloves.

1. On the shaft, insert in the following order:
2. Tool drive, metal cutting blade, drive washer, cover bell and the holding nut.
3. Secure the shaft by inserting a metal rod on the side of the drive gear and on the tool drive. Tighten the retaining nut counterclockwise with the supplied wrench.

#### **Disassembly:**

Insert a metal shaft locking pin into the hole on the side of the drive gear and on the tool drive. Loosen the retaining nut clockwise with the wrench and remove the cover bell, the drive washer and the metal cutting blade.

### **MOUNTING THE WIRE CUTTER HEAD (FIG 6)**

1. Add the tool drive on the spindle. Add and screw the wire head manually counterclockwise as shown (block the drive shaft rotation with the inserted rod).
2. Never use the brush head without the plastic housing.

#### **Disassembly:**

Manually remove the wire head. Secure the drive shaft with the metal rod inserted in Fig 6.

### **HARNESS ATTACHMENT**

To work with the device, always wear it with the harness. Before removing the harness, always turn off the appliance. There is a risk of injury.

1. Attach the harness
2. Adjust the length of the shoulder strap with the belt to 10 cm under the hips.

## **4. OPERATION**

### **OPERATING THE BRUSH MACHINE**

Do not use the device without the carter of protection. Before each use, make sure that the appliance is functional. Make sure the power supply matches the safety label. When working with the electric brush cutter, always wear protective equipment.

Protect yourself from noise and comply with local regulations. The use of the device may be prohibited or limited on certain days (Sundays and holidays), at certain times (noon, evening), or in certain areas (spas, clinics).

### **SWITCH ON / OFF (FIG 7)**

1. Connect the appliance to the power supply.

Be sure to stand upright and hold the device firmly with both hands. Do not place the cutting head on the floor.

2. To switch on, press the lock with the right thumb (B) and press or release the switch (A). Release the lock.

3. To stop, release the M / A button (A). Switching for continuous operation is not possible. After turning the unit off, the head continues to run for several seconds. The M / A switch must not be locked.

When released, the engine must stop. If the switch is damaged, do not continue working with the machine.

### **EXTENSION OF THE WIRE IN NYLON**

Your device is equipped with a two-wire automatic extension, tap the button of the wire head on the ground, brush cutter on, the wires will come out automatically. The length of the wires will be adjusted automatically by the cutting blade on the safety guard.

Caution: Regularly clean the wire knife to ensure proper cutting.

Check regularly that the nylon wire is not damaged and always has the correct length.

If the cutting power is reduced, turn the appliance on and hold it above the grass. Touch the floor with the head. The wires are automatically extended.

When the end of the wire is less than 2.5 cm:

- Switch off the appliance and disconnect it
- press the coil to lock it and pull the remaining wire strongly
- too short wires do not have enough centrifugal force to lengthen automatically

If you do not see the end of the thread:

- Replace the cutting head (see chapter Maintenance and cleaning).

### **CUTTING INSTRUCTIONS**

- Always wear appropriate harness and protective clothing during use.
- When starting or working, make sure that the cutting head does not touch any stone, gravel, wire or other foreign matter.
- During use, avoid too much effort on the equipment.
- Avoid contact with fixed objects (rock, wall, fence, batten, etc.). Use the crankcase edge to maintain the correct distance.
- Do not run over the cable with the machine running. This can cause damage. The cable must remain on the back of the user.
- Start the unit before approaching the lawn.
- Begin mowing from the electrical connection, do not approach the cutting head of the electric wire and work away from it.
- Cut the tall grass in several stages from top to bottom.
- Do not cut damp or wet grass.

### **WORKING WITH THE CUTTING HEAD**

- Short or worn wires cut badly. If there is an inefficient cut, check if there is any wire remaining in the coil. Read the paragraph Wire extension.
- During use, hold the cutting head just above the floor at all times and gently rotate the unit. Cut gently and keep the machine tilted about 30 ° forward.

### **WORKING WITH THE METAL BLADE**

Make sure the blade is properly mounted. Replace damaged or blunt blades. There is a risk of injury!

- Blades cut only free surfaces. Inspect the area thoroughly and remove any foreign matter. Avoid impacts with stones, metal or other obstacles. The blades could be damaged and there is a risk of retro-shock.
- Inspect the damaged blades regularly and replace if necessary.
- Do not use the appliance to cut rejects or thickets.
- During use, hold the head above the floor and rotate the appliance like a regular left and right arc.
- Do not hold the cutting head tilted.

## **5. MAINTENANCE AND STORAGE**

Before working on the appliance, unplug it.

If work is not described in this manual, it must be done by the authorized service. Use original parts and be careful when installing the cutting blade. There is a risk of injury!

Never use worn or non-original parts. Use only genuine parts. Never use metal wires. Use of non-original parts may result in adverse health effects and irreparable damage to the unit and immediately voids the warranty.

### **MAINTENANCE OF ANGLE RETURN**

Before each use, check and add, if necessary, the grease for the angle drive (Fig 8A).

Remove the screw on the side of the return housing. Lubricant Castrol LMX.  
See page 9 for the pictures for the maintenance.

### **REPLACING THE CUTTING HEAD (FIGURE 9)**

1. Disconnect the power supply.
2. Turn the appliance upwards to raise the head.
3. The coil housing and the coil are inserted only. To open, remove the cover (A) from the cover (C). Remove the coil (B).
4. The coil is supported by a spring, on either side of the spring there is a washer (top and bottom).
5. To reload coil D with wire, pull the wires through the eyelets (E) of the housing. Hold the wires in the eyelets (E) of the reel housing. Push the reel into the housing. Pull the two wires. Check that the resorts are properly installed. Replace the spool cover.
6. Press and hold the knob (D) and pull the thread sufficiently past the automatic thread cutter.

### **REPLACING THE BLADE (FIGURE 10)**

Check the blade.

1. Loosen the fastenings screws (B) and remove the blade (A).
2. Place a new knife and secure it with a screwdriver.

### **CLEANING**

- Clean and maintain the appliance regularly. This will ensure performance and durability.
- After each use, remove the grass and soil from the brush cutter and the safety guard.
- Keep the ventilation slots clean and free of grass.
- Clean the appliance with a soft brush or cloth.

Do not spray water on the appliance or soak it in water. Do not use detergent or solvent. The device would be irreparably damaged. Chemicals can attack the plastic parts of the device.

### **SERVICE AND SPARE PARTS**

Have your appliance checked by qualified personnel using original parts. This will ensure the safety of the tool. If you require technical advice, repairs or genuine parts, contact the SWAP service nearest you. For information or places of service, go to: [www.swap-europe.com](http://www.swap-europe.com).

When ordering spare parts, please indicate the part number, you can find them at: [www.swap-europe.com](http://www.swap-europe.com).

### **STORAGE**

- Clean your appliance and its accessories after each use. This prevents the formation of clusters.
- Store the device in a dry place away from dust and out of reach of children.
- Do not store the unit in direct sunlight.
- Do not place the appliance in plastic bags as mildew may appear.
- Do not place the unit under a protective cover. Hang it on a wall with the top of the handle. Make sure the cover does not touch anything. Otherwise, there is the risk of crankcase deformation and thus a change of the safety characteristics.

## **6. DISPOSAL**



Electrical products should not be discarded with household products. According to the European Directive 2012/19/EC on waste electrical and electronic equipment and its implementation into national law, electrical products used must be collected separately and disposed of at collection points provided for this purpose. Talk with your local authorities or dealer for advice on recycling.

# 7. DECLARATION OF CONFORMITY



**BUILDER SAS**

ZI, 32 rue aristide Bergès – 31270 Cugnaux - France  
Tel : +33 (0)5.34.502.502 Fax : +33 (0)5.34.502.503

declares that the machines:  
**ELECTRIC BRUSHCUTTER & GRASSTRIMMER**  
Model: HDCBE1400

Serial No.: 20231106401-20231106900

have been designed in compliance with the following standards:  
EN 60335-1:2012+A11:2014+A13:2017+A1:2019+A2:2019; EN 50636-2-91:2014  
EN62233:2008 ; EN 55014-1:2017; EN ISO11806-1: 2011  
EN 55014-2:2015 ; EN 61000-3-2:2014 ; EN 61000-3-3:2013

And in accordance with the following directives:

Directive Machine 2006/42/EC

Directive EMC 2014/30/EU

Rohs Directive (EU)2015/863 amending 2011/65/EU

Noise Directive 2000/14/EC Annex VI & Directive 2005/88/EC

Measured sound power level L<sub>wA</sub> : 95 dB (A) K=3 dB (A)

Guaranteed sound power level L<sub>wA</sub> : 96 dB (A) (According to ISO 2000/14/EC)

Notified body No: 0199

FORCE Technology • Park Allé 345 • DK-2605 Brøndby • Denmark • Tel: +45 43 25 00 00 • www.forcetechnology.com • VAT DK55117314

the people name holding the technical file: Mr.Olivier Patriarca

Philippe MARIE / PDG

Cugnaux, 16/10/2023

## 8. WARRANTY

# HYUNDAI

## WARRANTY

The manufacturer guarantees the product against defects in material and workmanship for a period of 2 years from the date of the original purchase. The warranty only applies if the product is for household use. The warranty does not cover breakdowns due to normal wear and tear.

The manufacturer agrees to replace parts identified as defective by the designated distributor. The manufacturer does not accept responsibility for the replacement of the machine, in whole or in part, and/or ensuing damage.

### The warranty does not cover breakdowns due to:

- insufficient maintenance.
- abnormal assembly, adjustment or operations of the product.
- parts subject to normal wear and tear.

### The warranty does not extend to:

- shipping and packaging costs.
- using the tool for a purpose other than that for which it was designed.
- the use and maintenance of the machine done in a manner not described in the user manual.

Due to our policy of continuous product improvement, we reserve the right to alter or change specifications without notice. Consequently, the product may be different from the information contained therein, but a modification will be undertaken without notice if it is recognized as an improvement of the preceding characteristic.

### READ THE MANUAL CAREFULLY BEFORE USING THE MACHINE.

When ordering spare parts, please indicate the part number or code, you can find this in the spare parts list in this manual. Keep the purchase receipt; without it, the warranty is invalid. To help you with your product, we invite you to contact us by phone or via our website:

- **+33 (0)9.70.75.30.30**
- **<https://services.swap-europe.com/contact>**

You must create a "ticket" via the web platform.

- Register or create your account.
- Indicate the reference of the tool.
- Choose the subject of your request.
- Describe your problem.
- Attach these files: invoice or sales receipt, photo of the identification plate (serial number), photo of the part you need (for example: pins on the transformer plug which are broken).



# 9. PRODUCT FAILURE

## WHAT TO DO IF MY MACHINE BREAKS DOWN?

### **If you bought your product in a store:**

- a) Empty the fuel tank if your product has one.
- b) Make sure that your machine is complete with all accessories supplied, and clean! If this is not the case, the repairer will refuse the machine.

Go to the store with the complete machine and with the receipt or invoice.

### **If you bought your product on a website:**

- a) Empty the fuel tank if your product has one..
- b) Make sure that your machine is complete with all accessories supplied, and clean! If this is not the case, the repairer will refuse the machine.
- c) Create a SWAP-Europe service ticket on the site: <https://services.swap-europe.com> When making the request on SWAP-Europe, you must attach the invoice and the photo of the nameplate (serial number).
- d) Contact the repair station to make sure it is available before dropping off the machine.

Go to the repair station with the complete machine packed, accompanied by the purchase invoice and the station support sheet downloadable after the service request is completed on the SWAP-Europe site

For machines with engine failure from manufacturers BRIGGS & STRATTON, HONDA and RATO, please refer to the following instructions.

Repairs will be done by approved engine manufacturers of these manufacturers, see their site:

- <http://www.briggsandstratton.com/eu/fr>
- <http://www.honda-engines-eu.com/fr/service-network-page;jsessionid=5EE8456CF39CD572AA2AEEDFD290CDAE>
- <https://www.rato-europe.com/it/service-network>

**Please keep your original packaging to allow for after-sales service returns or pack your machine with a similar cardboard box of the same dimensions.**

**For any question concerning our after-sales service you can make a request on our website <https://services.swap-europe.com>**

**Our hotline remains available at +33 (9) 70 75 30 30.**



# 10. WARRANTY EXCLUSIONS

## THE WARRANTY DOES NOT COVER:

- Start-up and setting up of the product.
- Damage resulting from normal wear and tear of the product.
- Damage resulting from improper use of the product.
- Damage resulting from assembly or start-up not in accordance with the user manual.
- Breakdowns related to carburetion beyond 90 days and fouling of carburetors.
- Periodic and standard maintenance events.
- Actions of modification and dismantling that directly void the warranty.
- Products whose original authentication marking (brand, serial number) has been degraded, altered or withdrawn.
- Replacement of consumables.
- The use of non-original parts.
- Breakage of parts following impacts or projections.
- Accessories breakdowns.
- Defects and their consequences linked to any external cause.
- Loss of components and loss due to insufficient screwing.
- Cutting components and any damage related to the loosening of parts.
- Overload or overheating.
- Poor power supply quality: faulty voltage, voltage error, etc.
- Damages resulting from the deprivation of enjoyment of the product during the time necessary for repairs and more generally the costs related to the immobilization of the product.
- The costs of a second opinion established by a third party following an estimate by a SWAP-Europe repair station
- The use of a product which would show a defect or a breakage which was not the subject of an immediate report and/or repair with the services of SWAP-Europe.
- Deterioration linked to transport and storage\*.
- Launchers beyond 90 days.
- Oil, petrol, grease.
- Damages related to the use of non-compliant fuels or lubricants.

\* In accordance with transport legislation, damage related to transport must be declared to carriers within 48 hours maximum after observation by registered letter with acknowledgement of receipt.

This document is a supplement to your notice, a non-exhaustive list.

**Attention:** all orders must be checked in the presence of the delivery person. In case of refusal by the delivery person, it you must simply refuse the delivery and notify your refusal.

**Reminder:** the reserves do not exclude the notification by registered letter with acknowledgement within 72 hours.

**Information:** Thermal devices must be wintered each season (service available on the SWAP-Europe site). Batteries must be charged before being stored.

**HYUNDAI**  
POWER PRODUCTS



GENUINE PRODUCT OF  
HYUNDAI CORPORATION

**For Inquiries, please contact:**

**BUILDER SAS**

32, Rue Aristide Bergès Z1 31270 Cugnaux, France

Tél.: +33(0)5.34.502.502 Fax : +33(0)5.34.502.503

<http://www.hyundaipower-fr.com/>

Fabriqu  en R publique Populaire de Chine(PRC)

Import e par BUILDER SAS, France

Licensed by Hyudai Corporation, Korea